



DATASHEET

Characteristics

Material properties

Nom. tensile strength: 2.050 (N/mm²)
 Young's modulus: 200.000 (N/mm²)
 Strain at ultimate strength: 0,8 %

Geometry

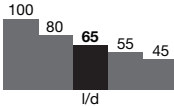
fibres family **3D** 
 Length (l) 50 mm 
 Diameter (d) 0,9 mm 
 Aspect ratio (l/d) 65 

Minimum EN 14889-1 dosage

15 kg/m³

Fibre network

4.319 m/m³ at 15 kg/m³
 5.602 fibres/kg

Dramix® family

3D Typical SFRC applications
 4D Supreme serviceability control
 5D Advanced structural applications

	5D	4D	3D
Tensile strength	██████████	██████████	██████████
Wire ductility	██████████	██████████	██████████
Anchorage strength	██████████	██████████	██████████

Product certificates*



* Product certificates are plant specific.

Product conformity

Dramix® conforms to ASTM A820, EN 14889-1 and ISO 13270 Class A.

System certificates



All Dramix® plants are ISO 9001 and ISO 14001 certified.

Packaging



BAGS
20 kg



BIG BAG
1.100 kg

Handling



DRAMIX® 3D 65/50BGP

The original anchorage

Dramix® 3D is the cost-efficient fibre for standard statically indeterminate concrete structures that are submitted to regular static, fatigue and dynamic loadings.

Glue technology for three-dimensional reinforcement

Dramix® steel fibres are bundled with water-soluble glue. The glue helps avoiding fibre balling during mixing and ensures a homogeneous distribution of fibres throughout the concrete mix.

The high performant strength

Dramix® 3D Premium is a high performant fibre to create optimal ductility in high strength concrete.

Bekaert construction support

You can count on our support for each step of your project, from concept design to on-site quality support. Our services include recommendations on slab design, construction detailing, concrete optimization and automatic total quality control procedures. We are also happy to share our knowledge with you and your team.

Feel free to ask us for a workshop or training on the topic of steel fibre reinforcement in your offices.

For recommendations on handling, dosing and mixing visit www.bekaert.com/dosingdramix. Any other specific document or certificate can be found on www.bekaert.com/dramix/downloads.