



**80 / 60 BG**

Aspect ratio

Length

Bright

Glued



**DATASHEET**

**Characteristics**

**Material properties**

Nom. tensile strength: 1.225 (N/mm<sup>2</sup>)  
 Young's modulus: 200.000 (N/mm<sup>2</sup>)  
 Strain at ultimate strength: 0,8 %

**Geometry**

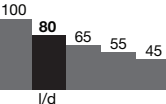
fibres family **3D**   
 Length (l) 60 mm   
 Diameter (d) 0,75 mm   
 Aspect ratio (l/d) 80 

**Minimum EN 14889-1 dosage**

10 kg/m<sup>3</sup>

**Fibre network**

2.879 m/m<sup>3</sup> at 10 kg/m<sup>3</sup>  
 4.690 fibres/kg

**Dramix® family**

3D Typical SFRC applications  
 4D Supreme serviceability control  
 5D Advanced structural applications

	5D	4D	3D
Tensile strength			
Wire ductility			
Anchorage strength			

**Product certificates\***



\* Product certificates are plant specific.

**Product conformity**

Dramix® conforms to ASTM A820, EN 14889-1 and ISO 13270 Class A.

**System certificates**



All Dramix® plants are ISO 9001 and ISO 14001 certified.

**Packaging**



**BAGS**  
20 kg



**BIG BAG**  
800 - 1.100 kg

**Handling**



**DRAMIX® 3D 80/60BG**

**The original anchorage**

Dramix® 3D is the cost-efficient fibre for standard statically indeterminate concrete structures that are submitted to regular static, fatigue and dynamic loadings.

**Glue technology for three-dimensional reinforcement**

Dramix® steel fibres are bundled with water-soluble glue. The glue helps avoiding fibre balling during mixing and ensures a homogeneous distribution of fibres throughout the concrete mix.

**Bekaert construction support**

You can count on our support for each step of your project, from concept design to on-site quality support. Our services include recommendations on slab design, construction detailing, concrete optimization and automatic total quality control procedures. We are also happy to share our knowledge with you and your team.

Feel free to ask us for a workshop or training on the topic of steel fibre reinforcement in your offices.

For recommendations on handling, dosing and mixing visit [www.bekaert.com/dosingdramix](http://www.bekaert.com/dosingdramix). Any other specific document or certificate can be found on [www.bekaert.com/dramix/downloads](http://www.bekaert.com/dramix/downloads).